

MEDIDAS HALL PRINCIPAL PALACIO

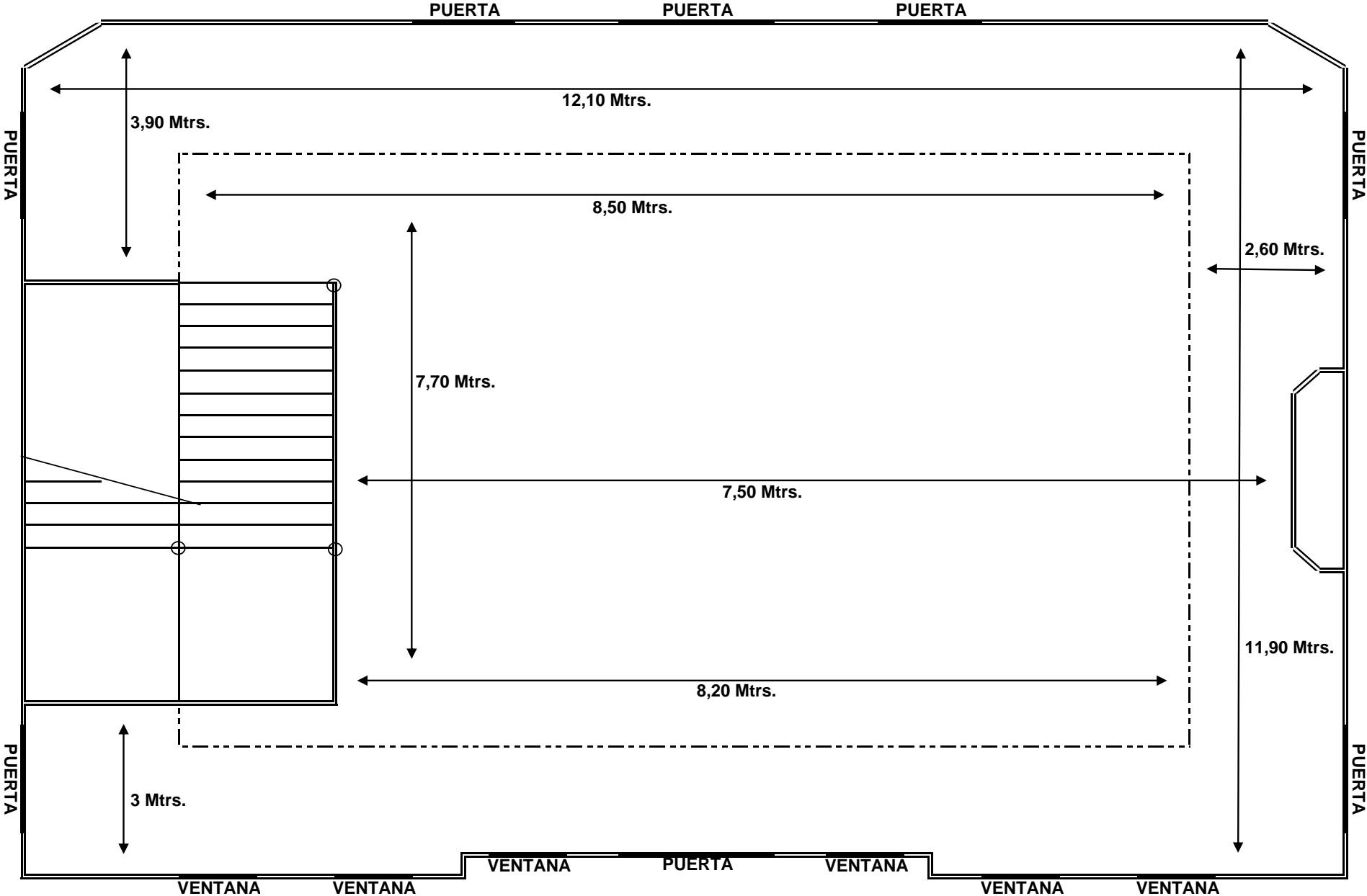

RELACION MESAS DE PARANINFO

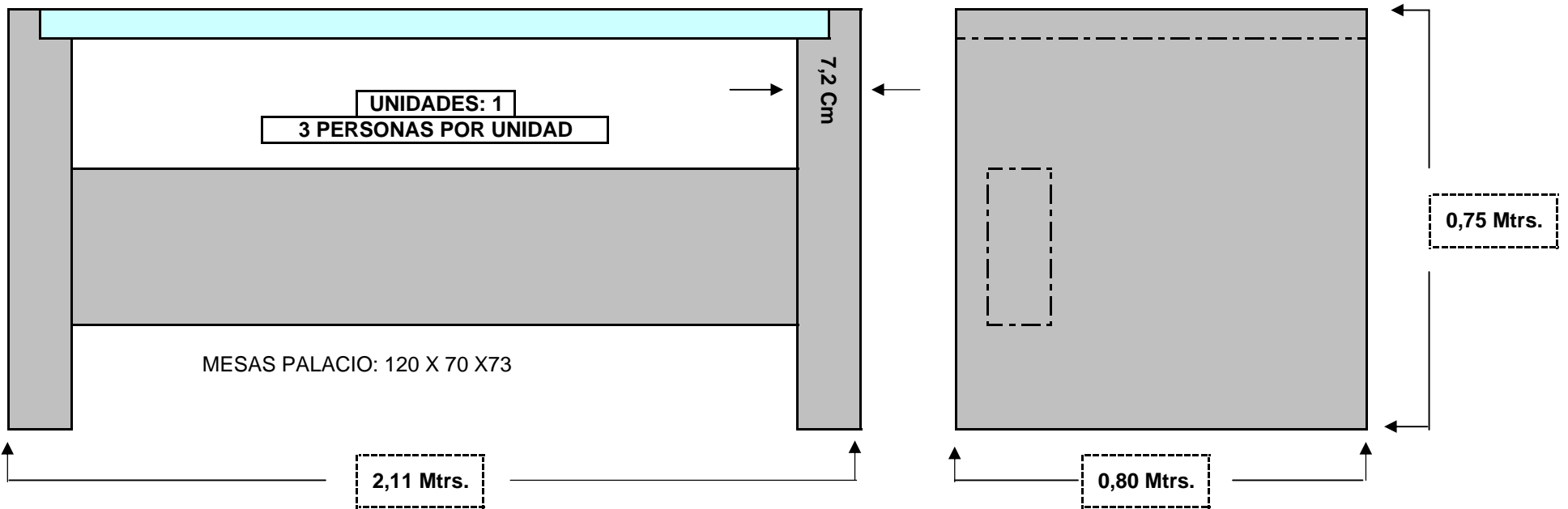
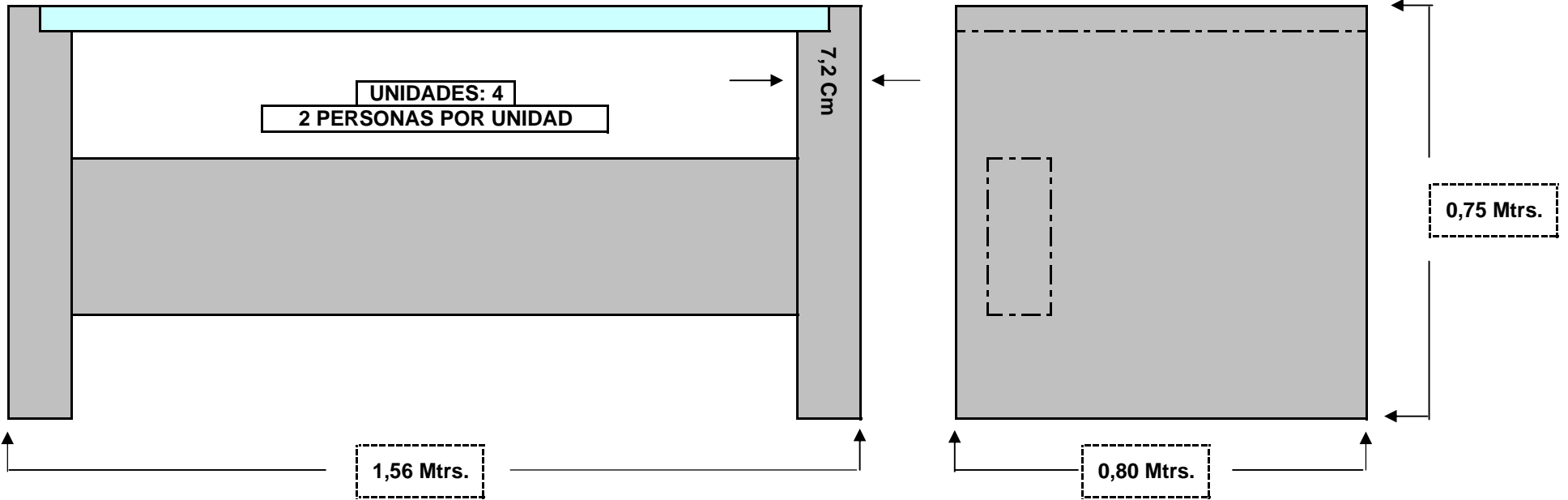

RELACION MESAS DE PARANINFO

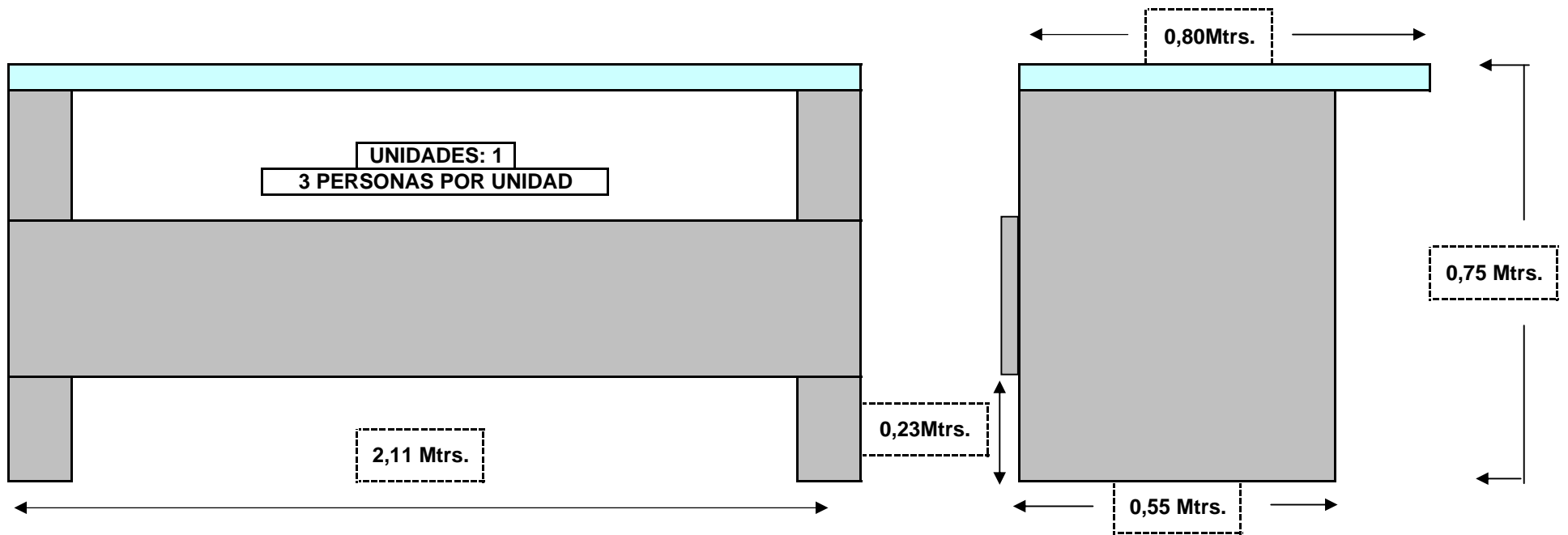
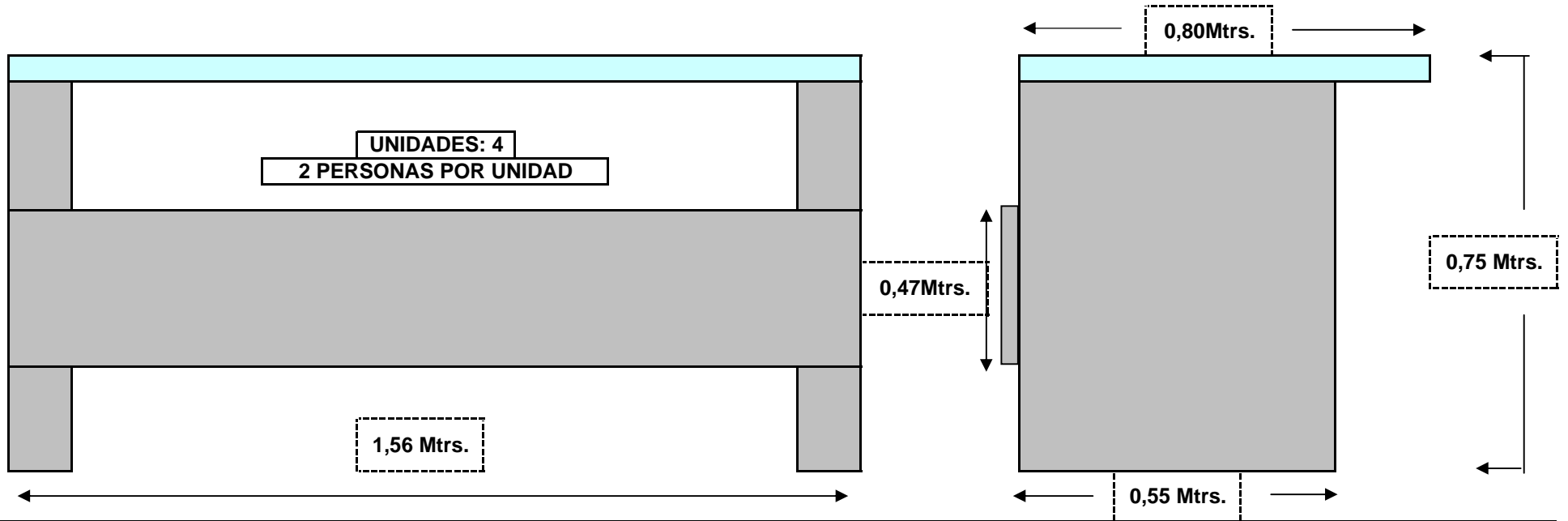

MEDIDAS ATRIL DE PARANINFO

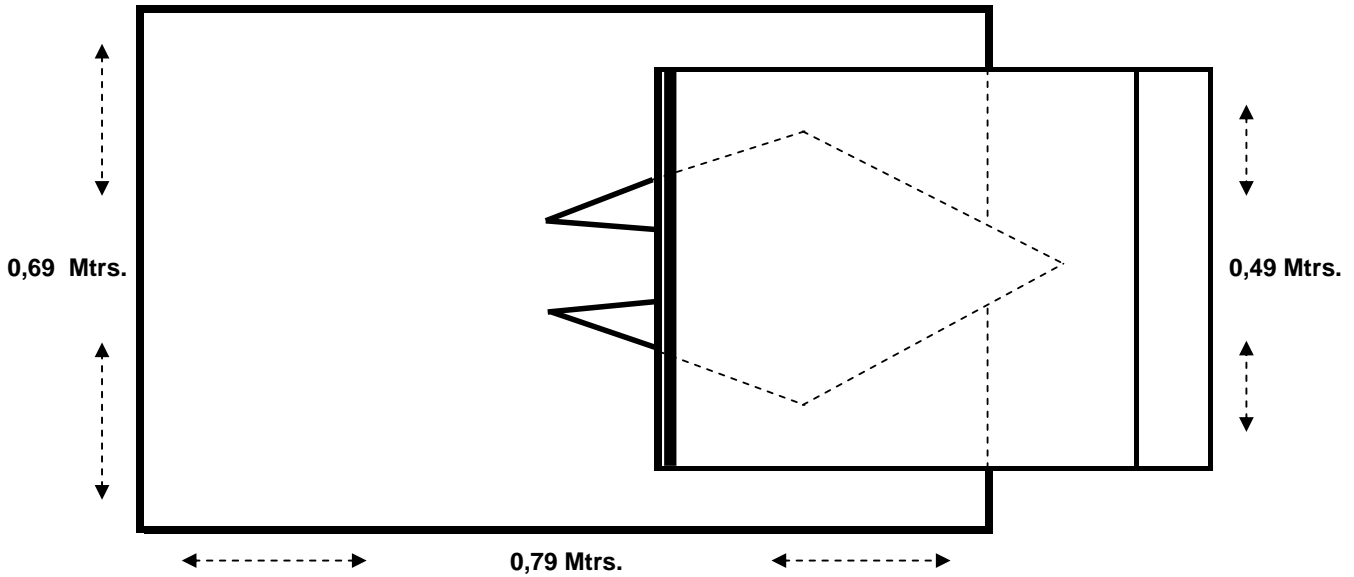
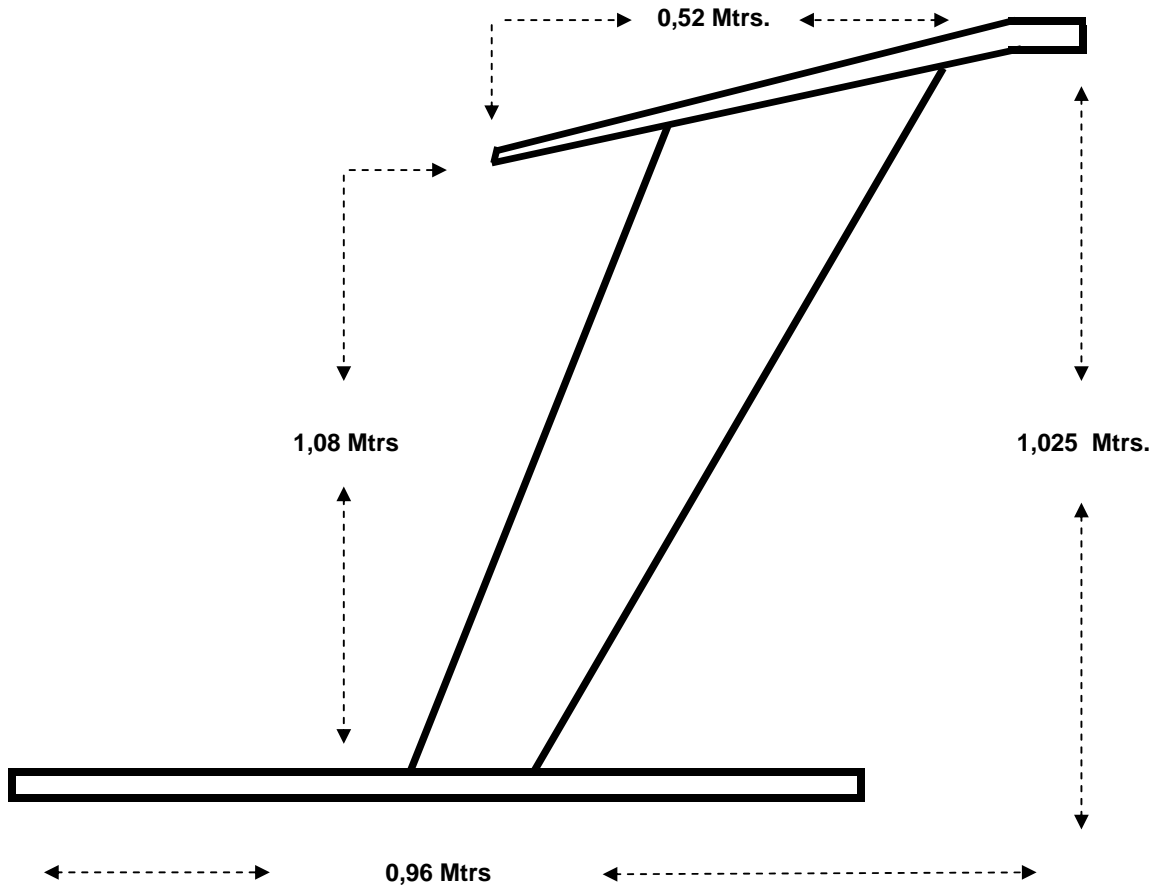

MEDIDAS HALL PLANTA BAJA

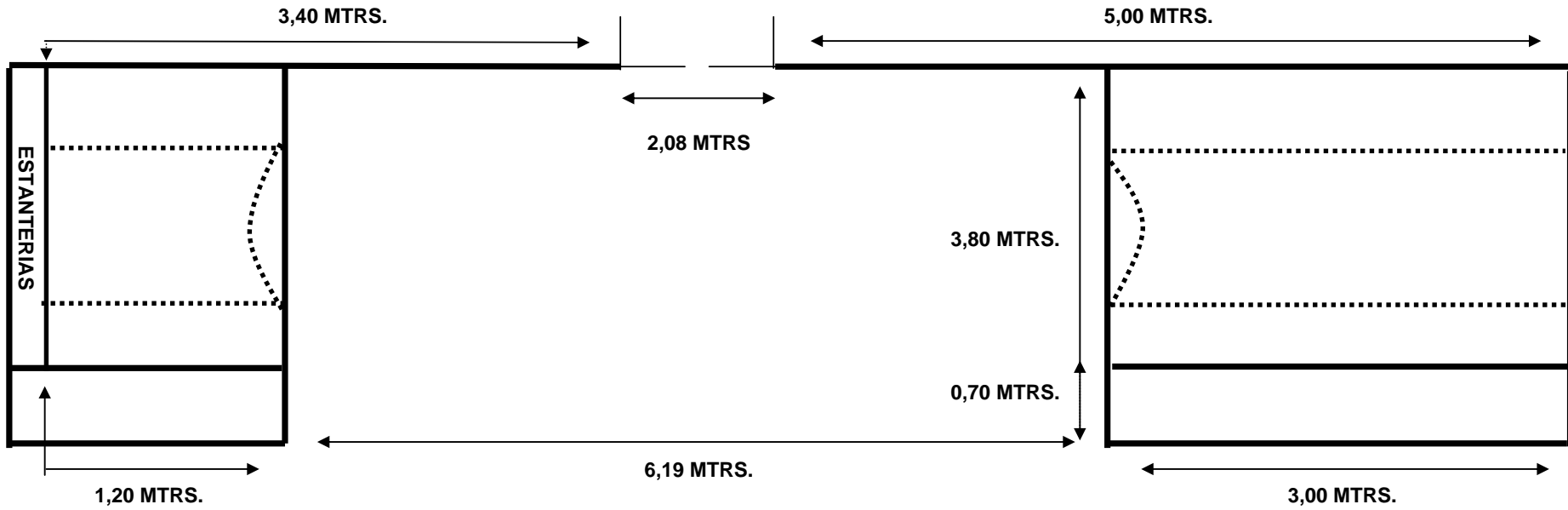
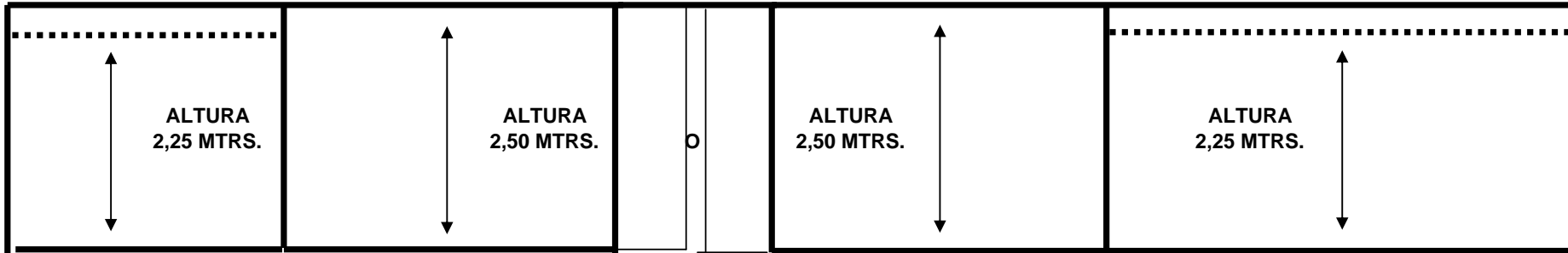

MEDIDAS COMEDORES PALACIO

COMEDOR GRANDE

ALTURA 2,40 Mtrs.

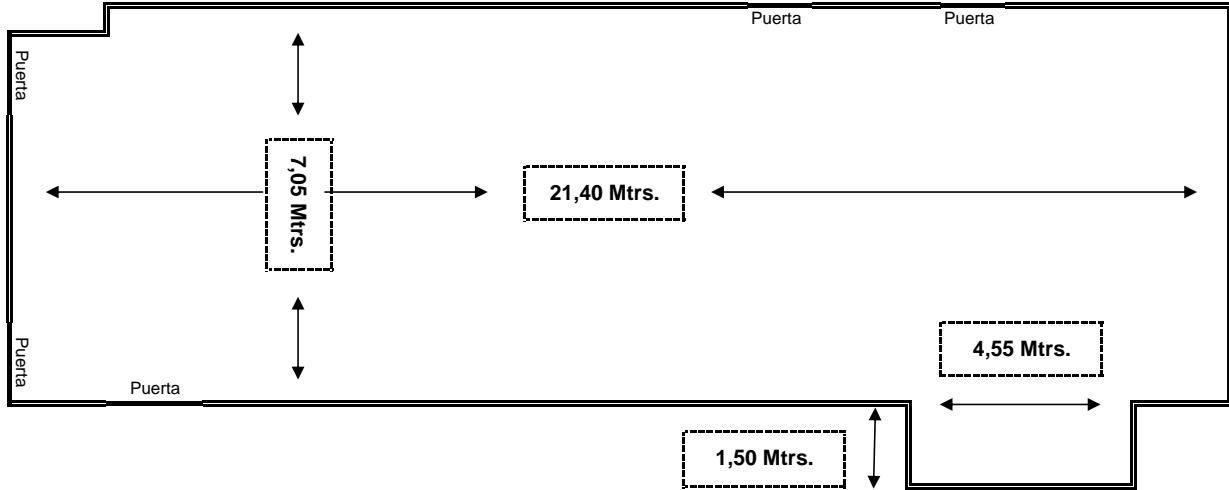

COMEDOR PEQUEÑO

ALTURA 2,40 Mtrs.

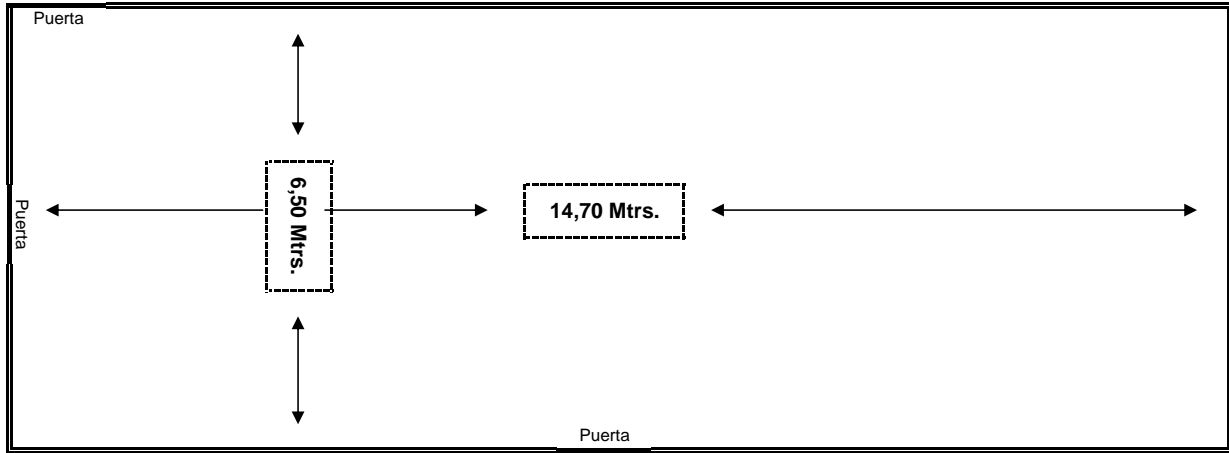

MEDIDAS PABELLON MUNICIPAL 20/06/00

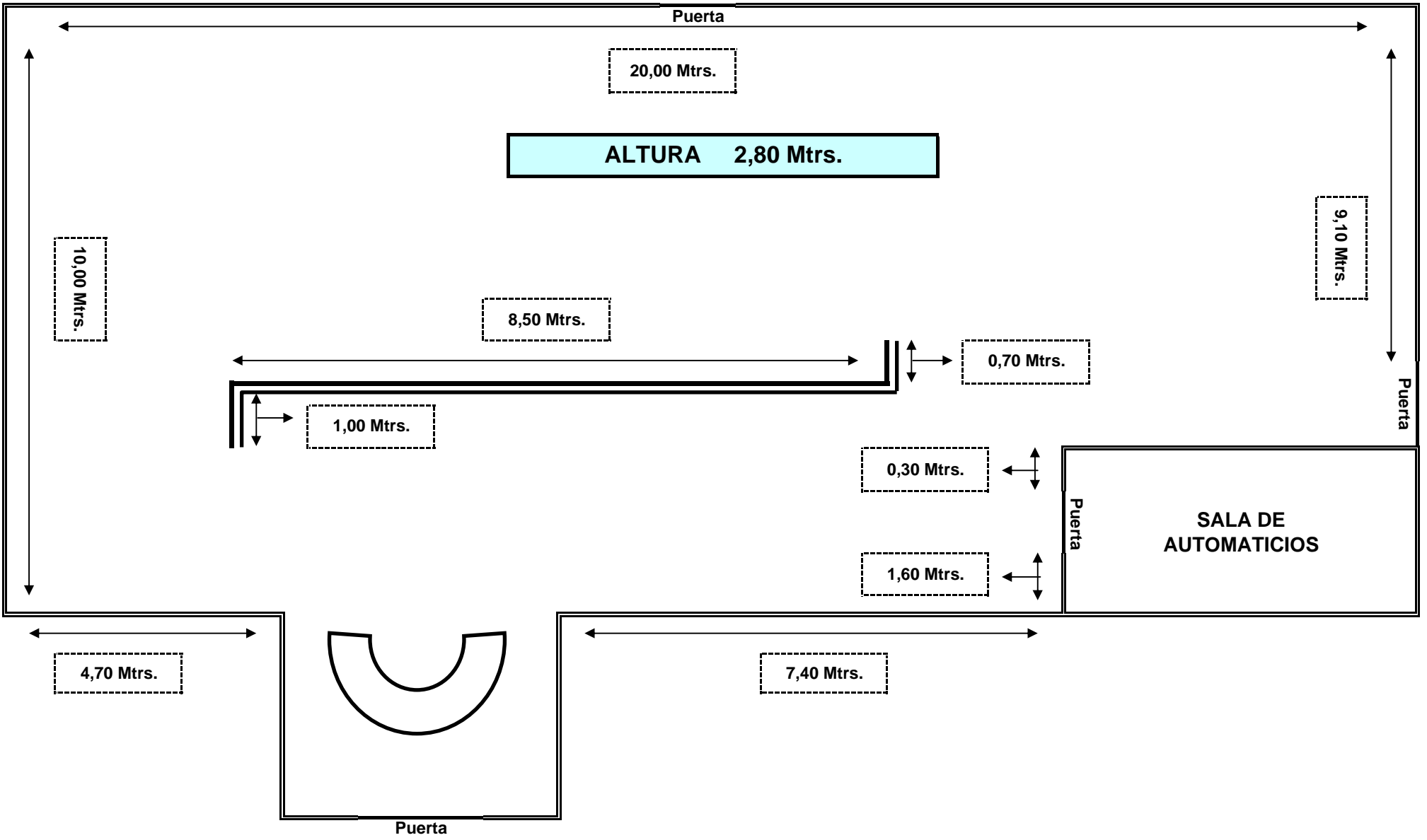

MEDIDAS PABELLON MUNICIPAL 20/06/00

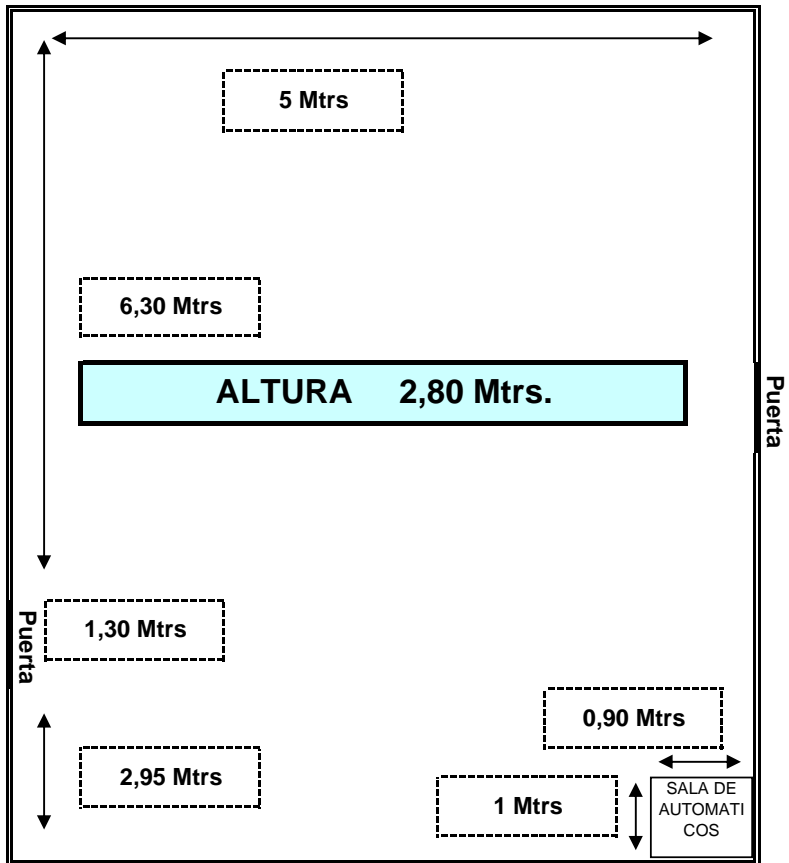

MEDIDAS AULA RIANCHO Y SALON DE BAILE

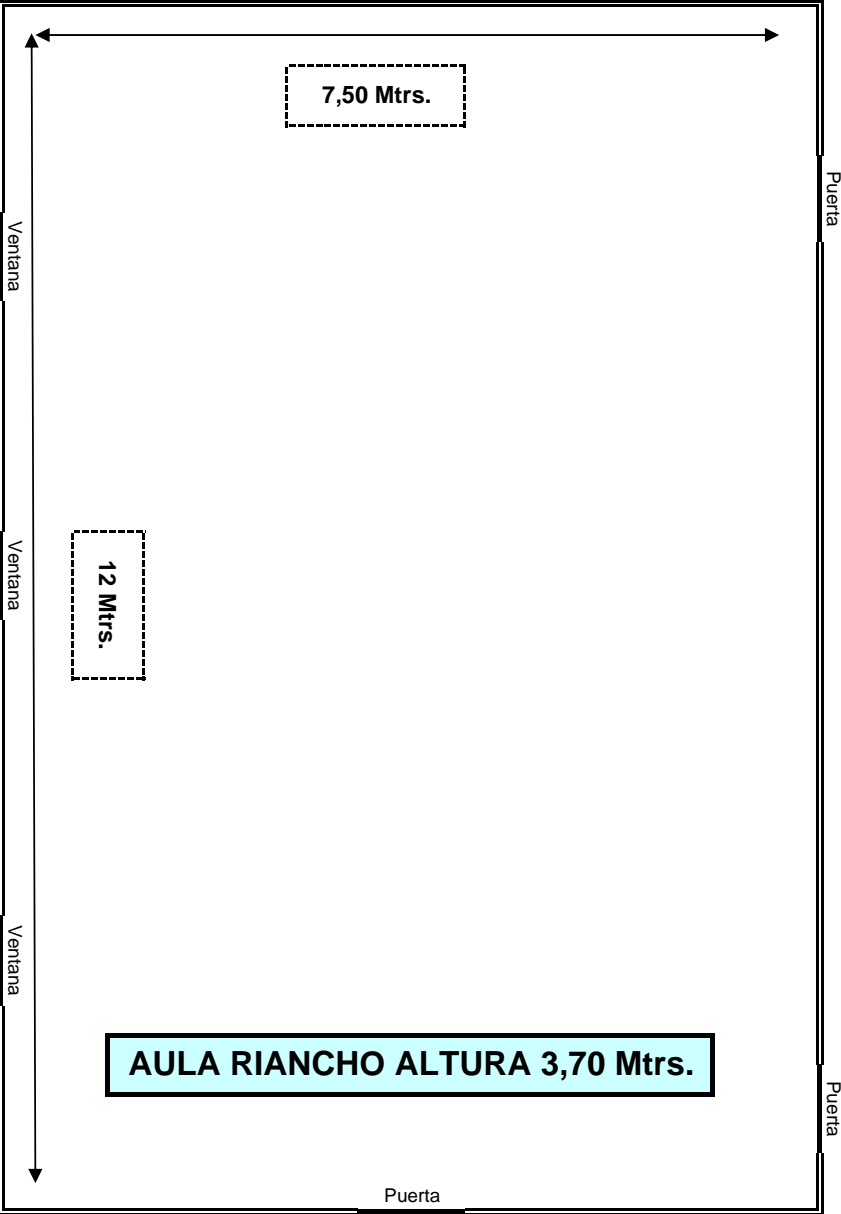

MEDIDAS COMEDOR DE CABALLERIZAS

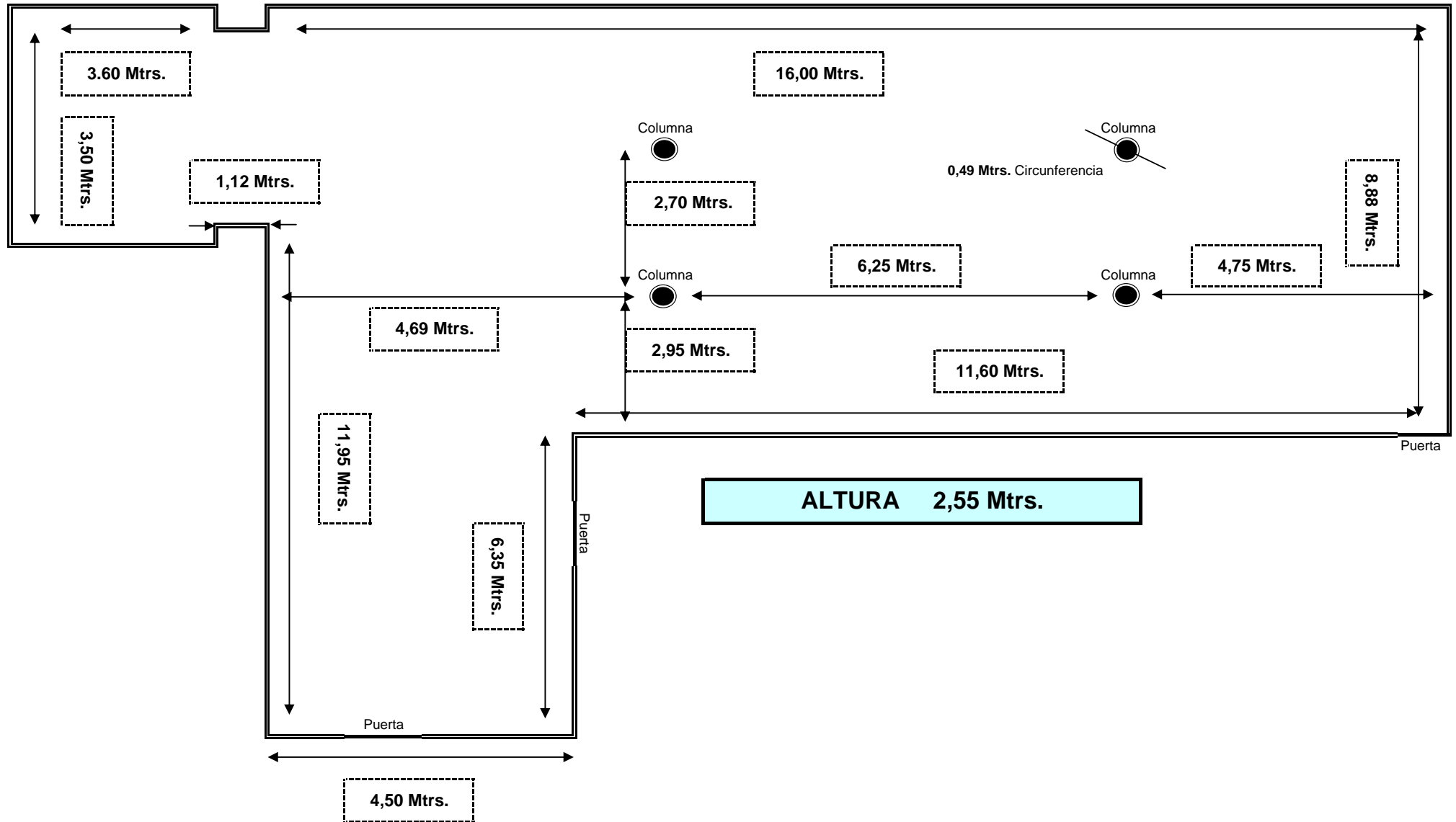

MEDIDAS AULAS DE CABALLERIZAS

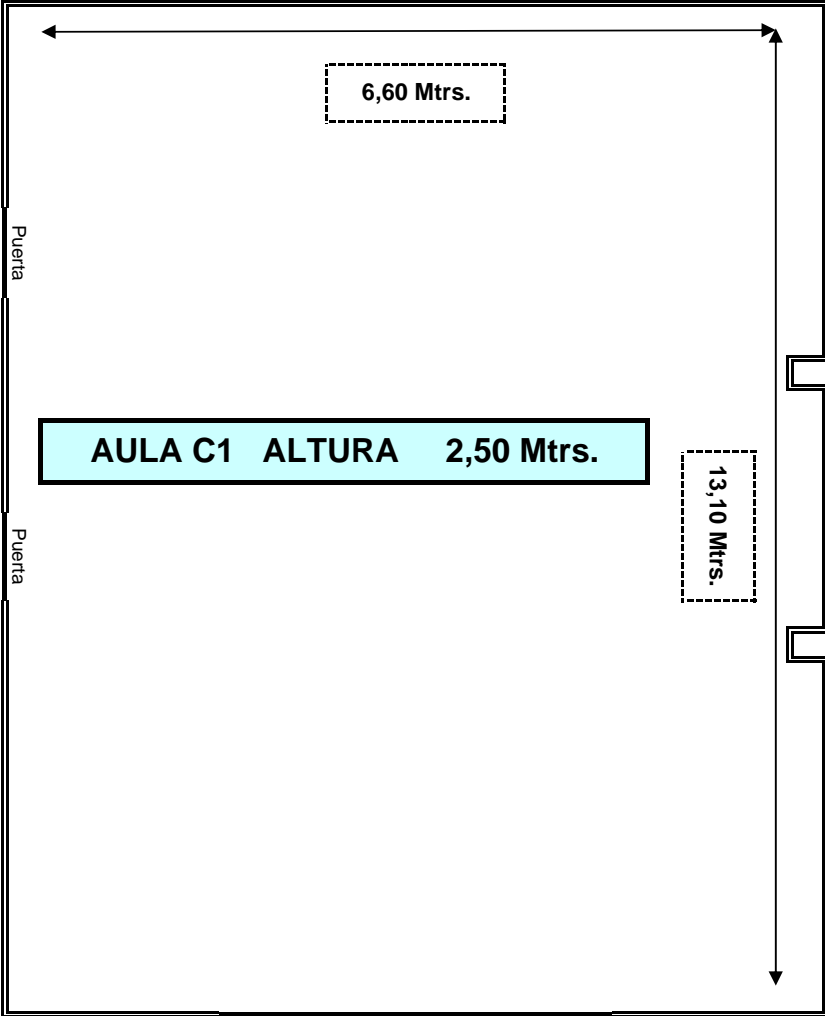
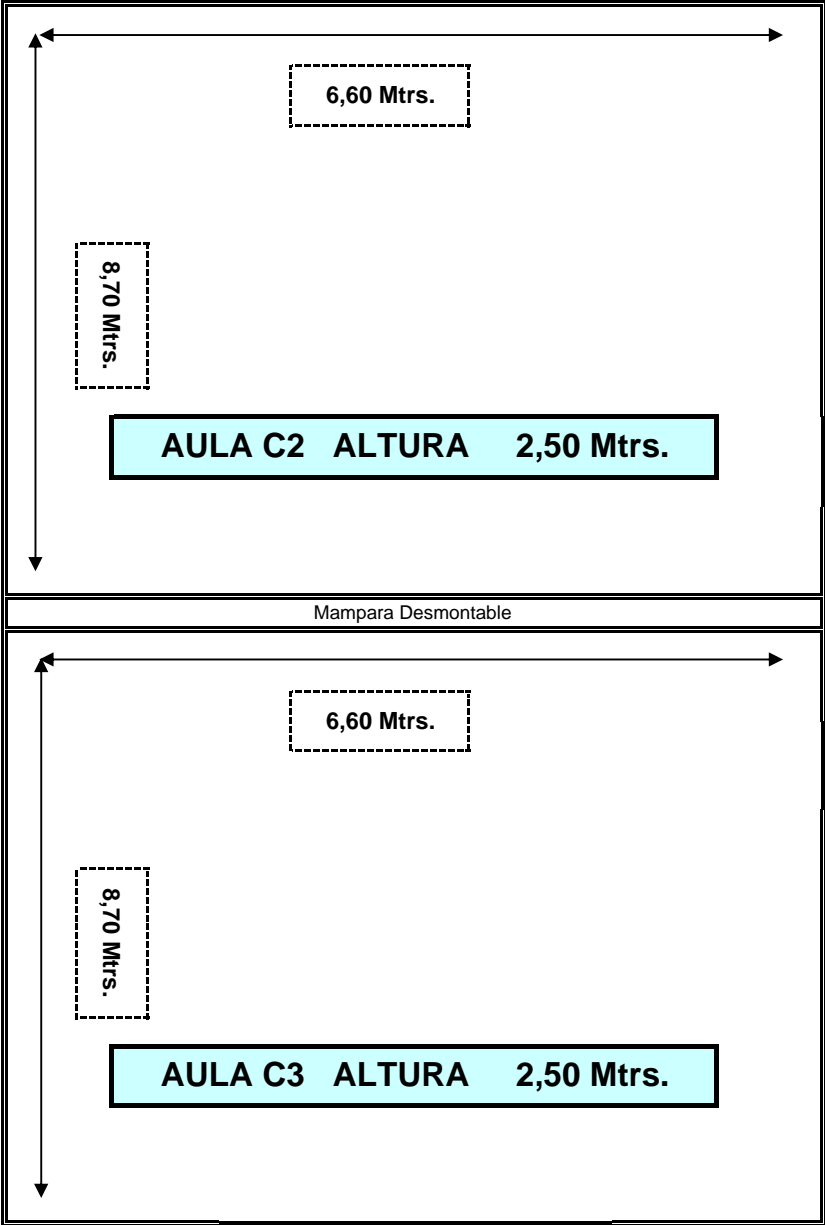

MEDIDAS SALA PROGRAMACION DE PALACIO

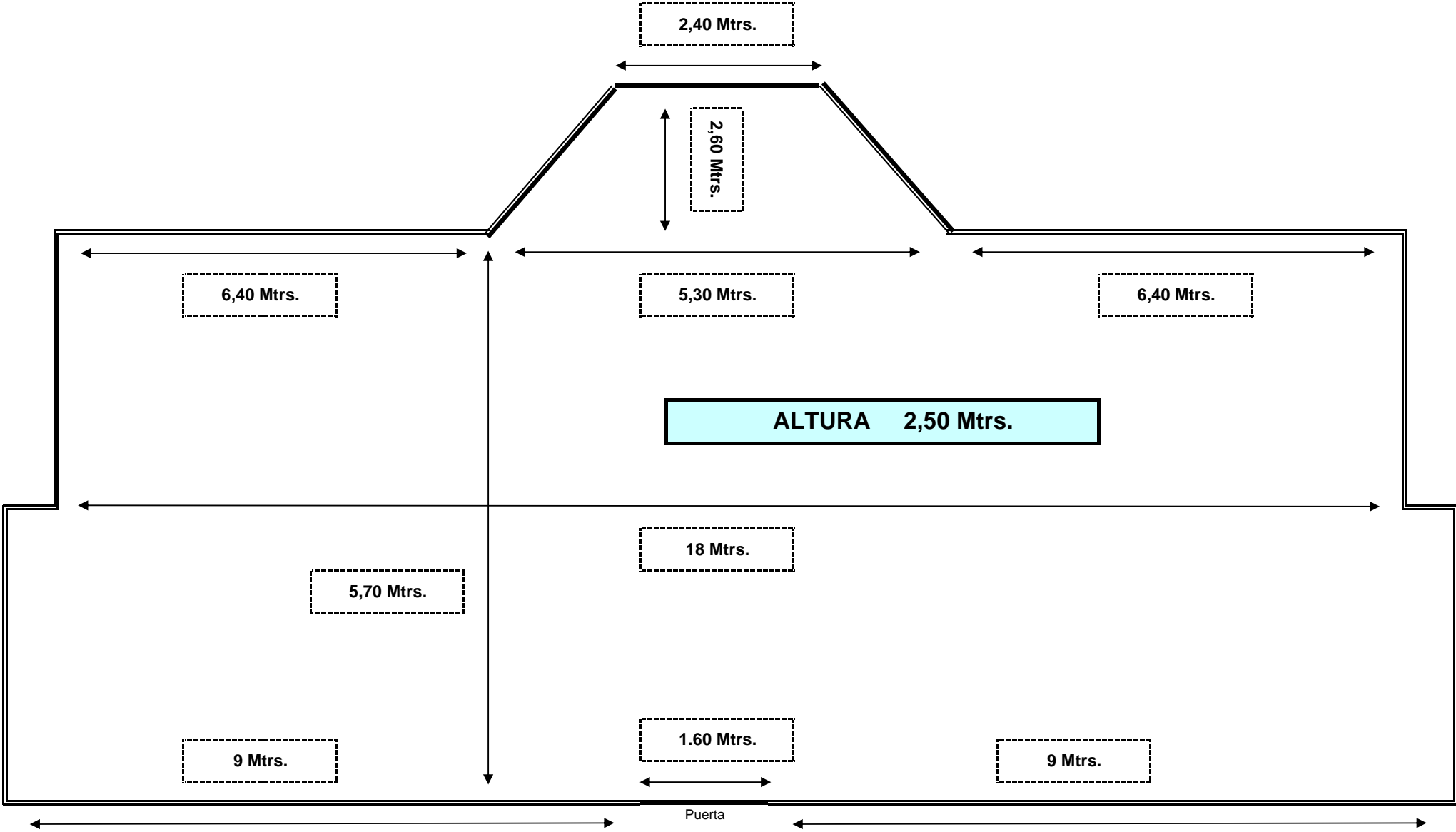

MEDIDAS SALA HABILITACION DE PALACIO

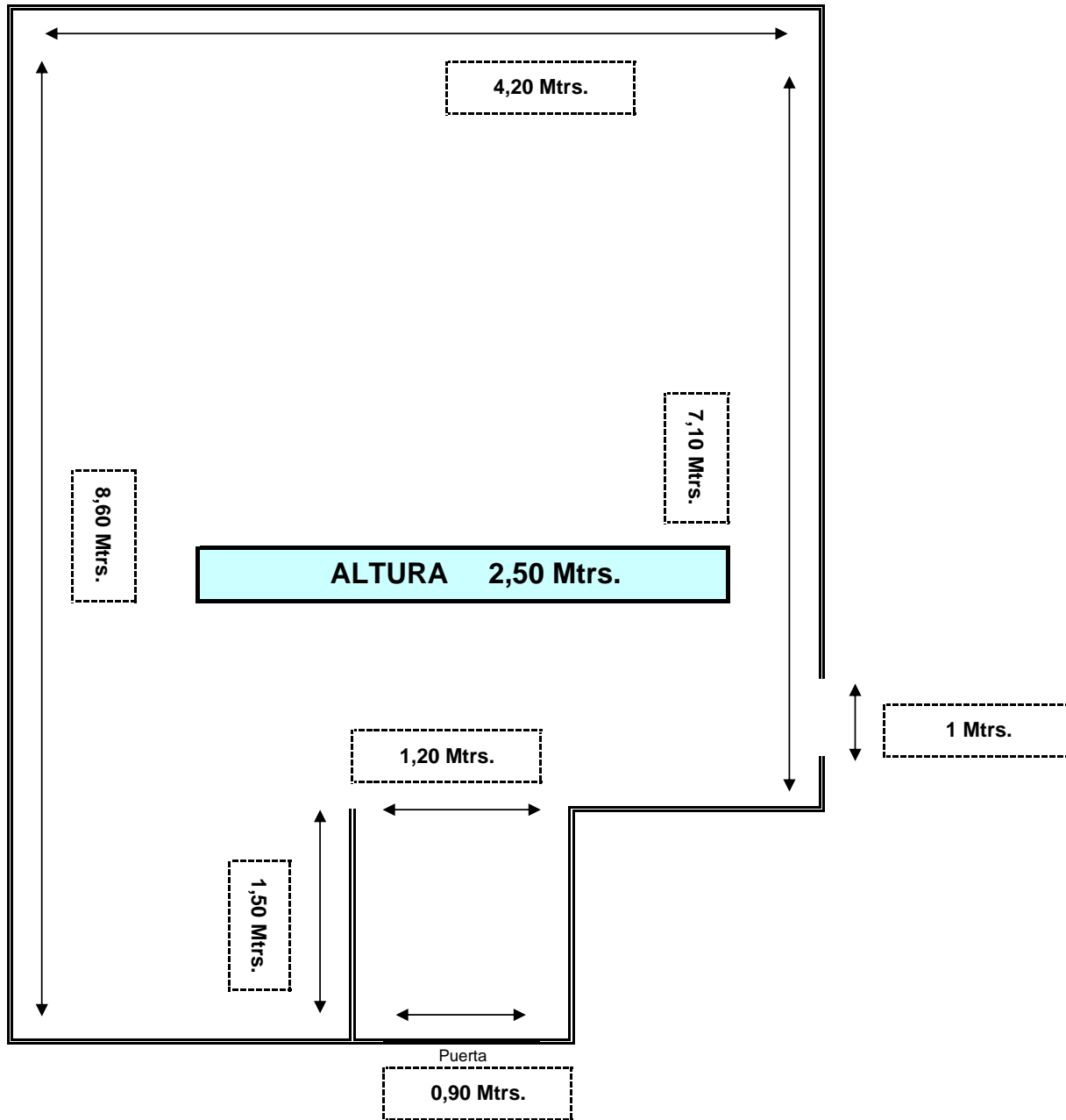

MEDIDAS SALA SECRETARIA ALUMNOS 1 DE PALACIO

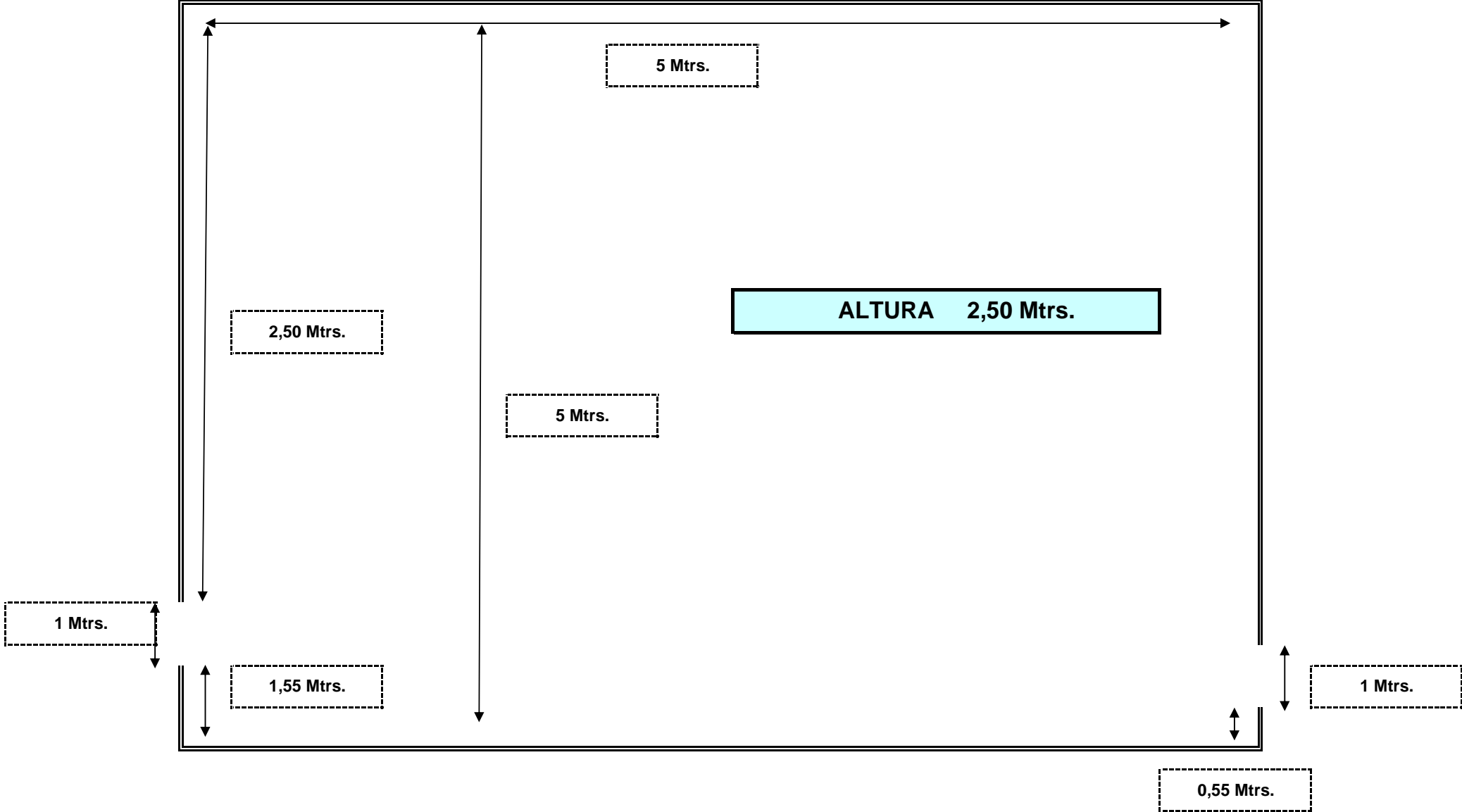

MEDIDAS SALA SECRETARIA ALUMNOS 2 DE PALACIO

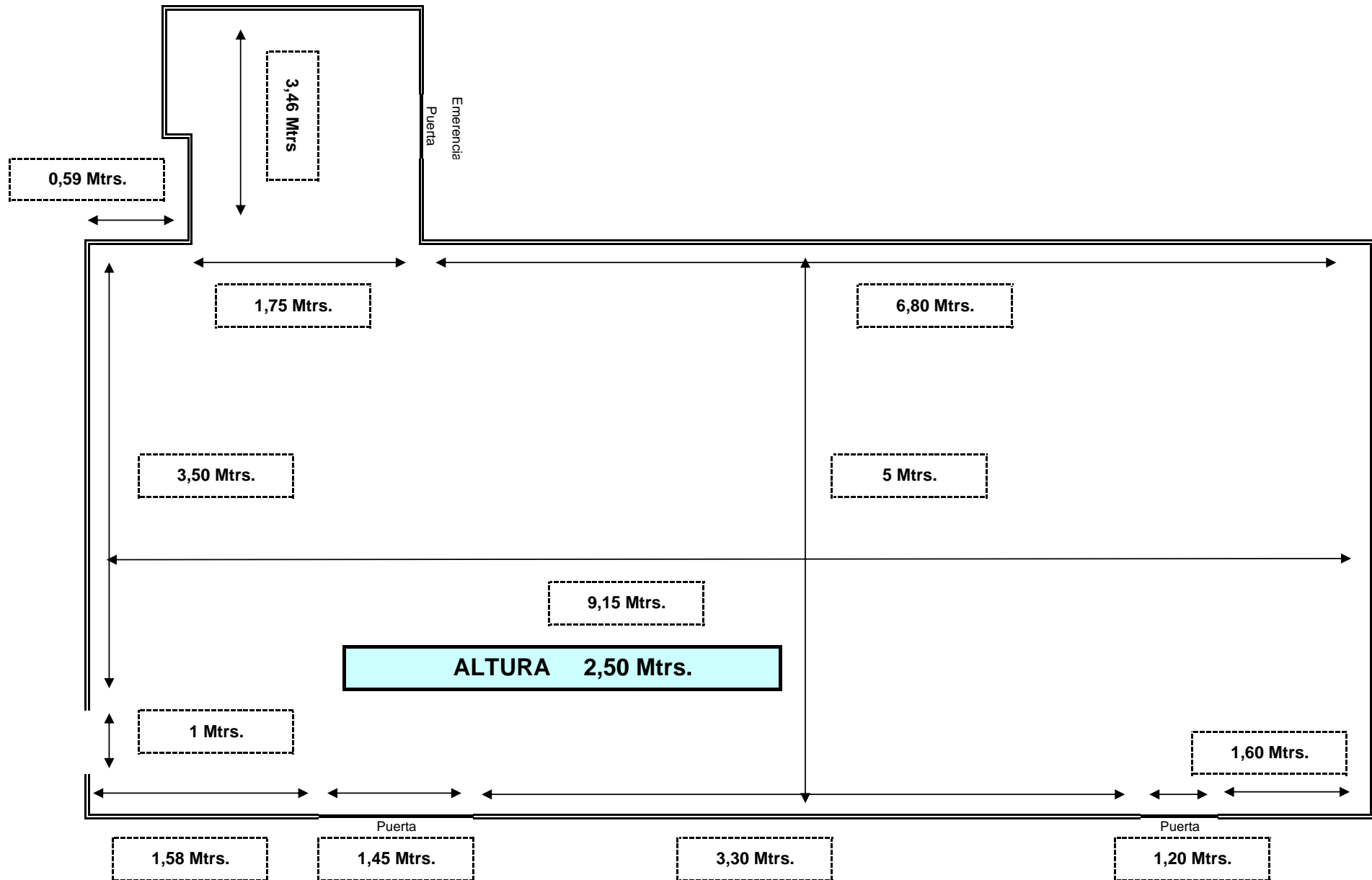

MEDIDAS PATIO DEL RELOJ CABALLERIZAS

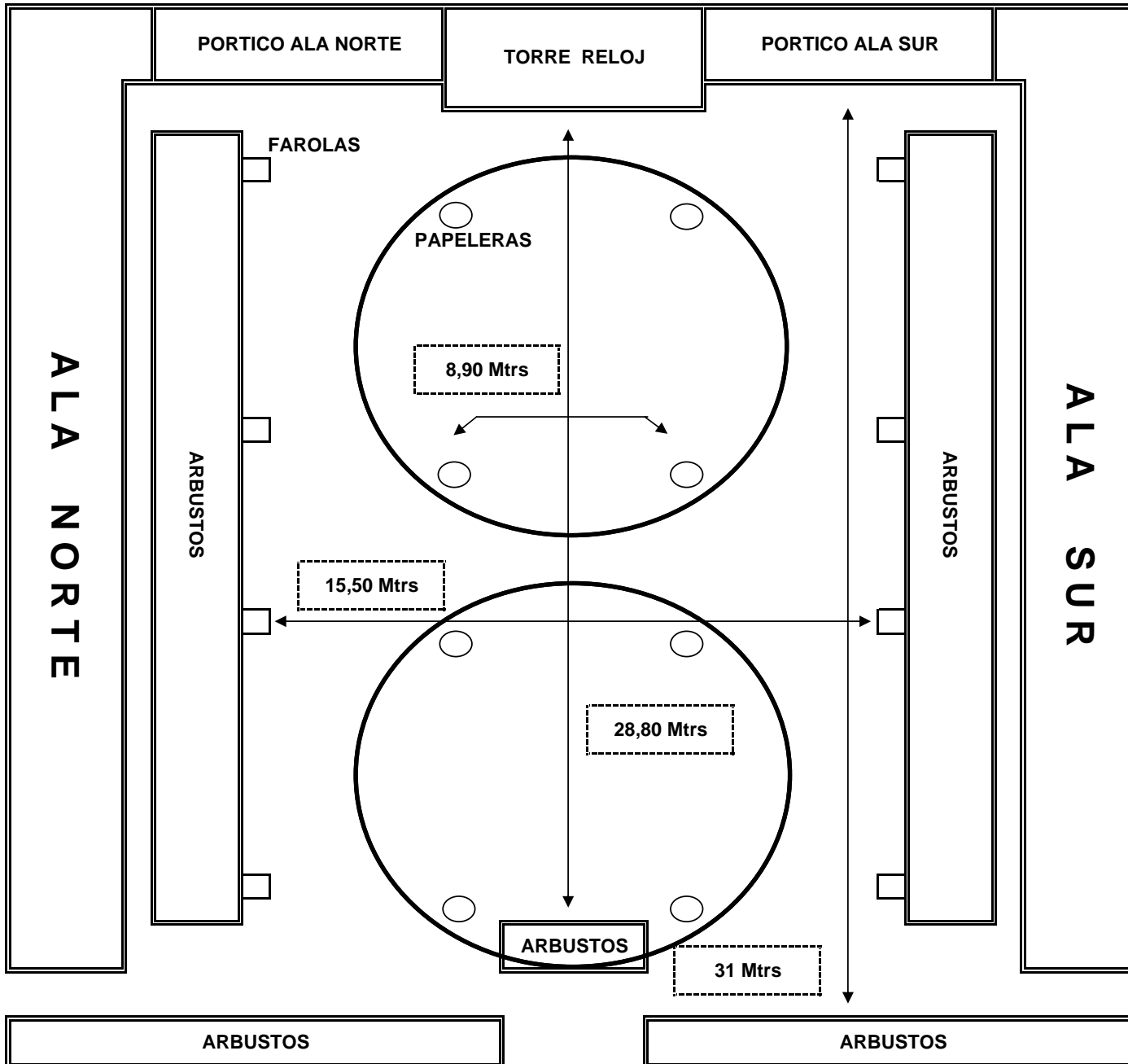

MEDIDAS HALL ENTRADA PARANINFO Y ALTURA TELONES ESCENARIO

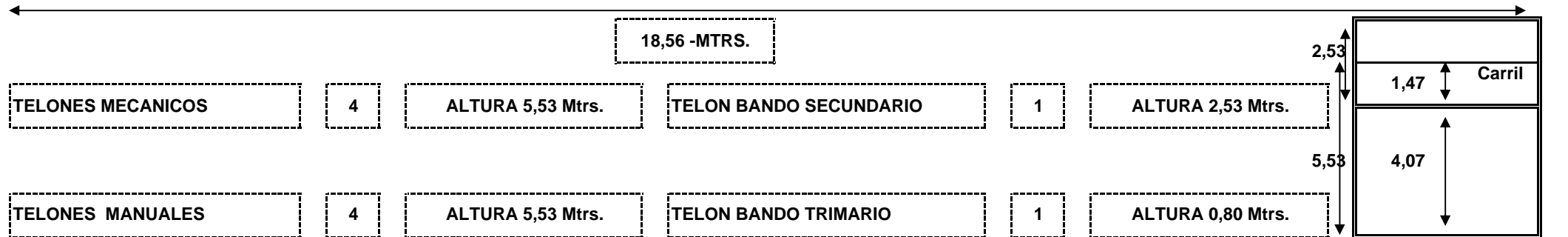
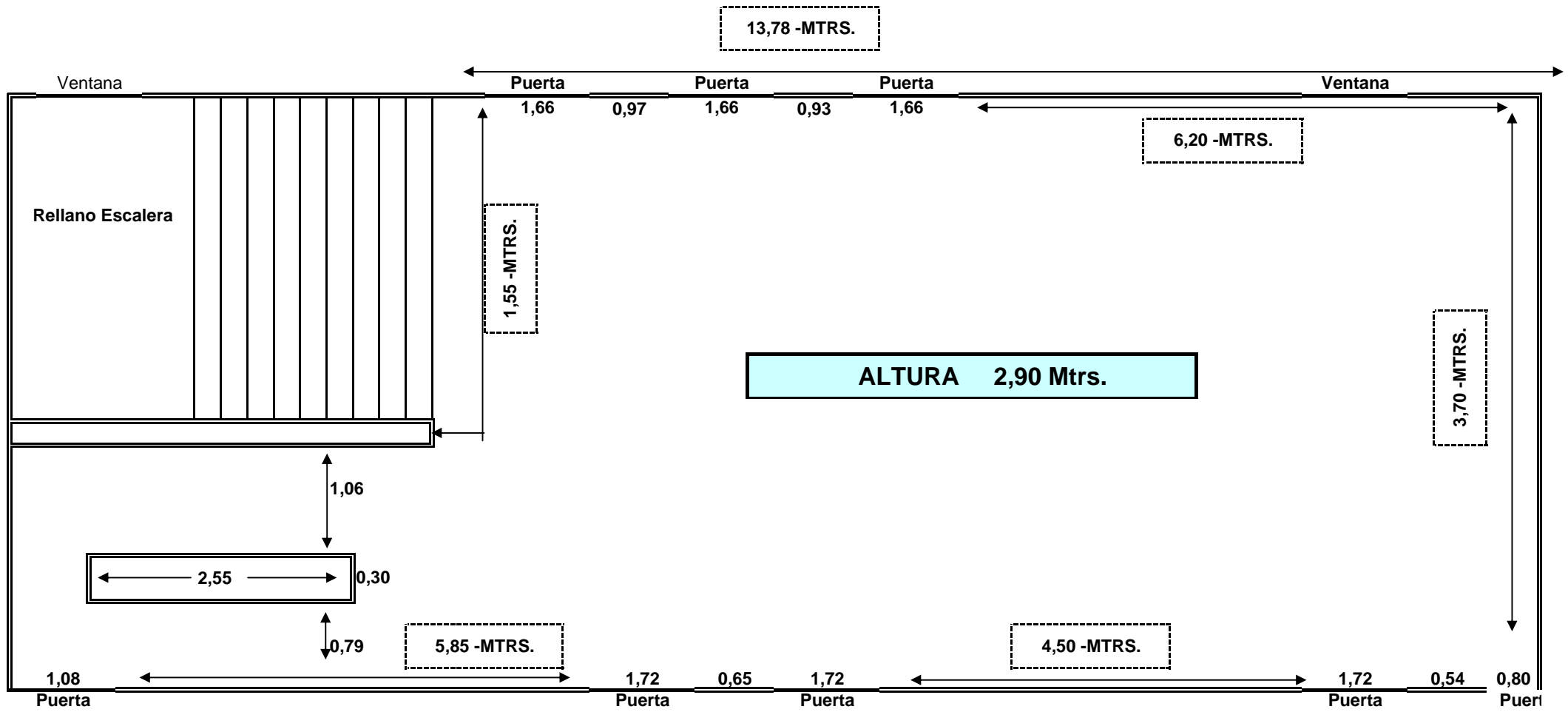

MEDIDAS ENTRE COLUMNAS PARANINFO

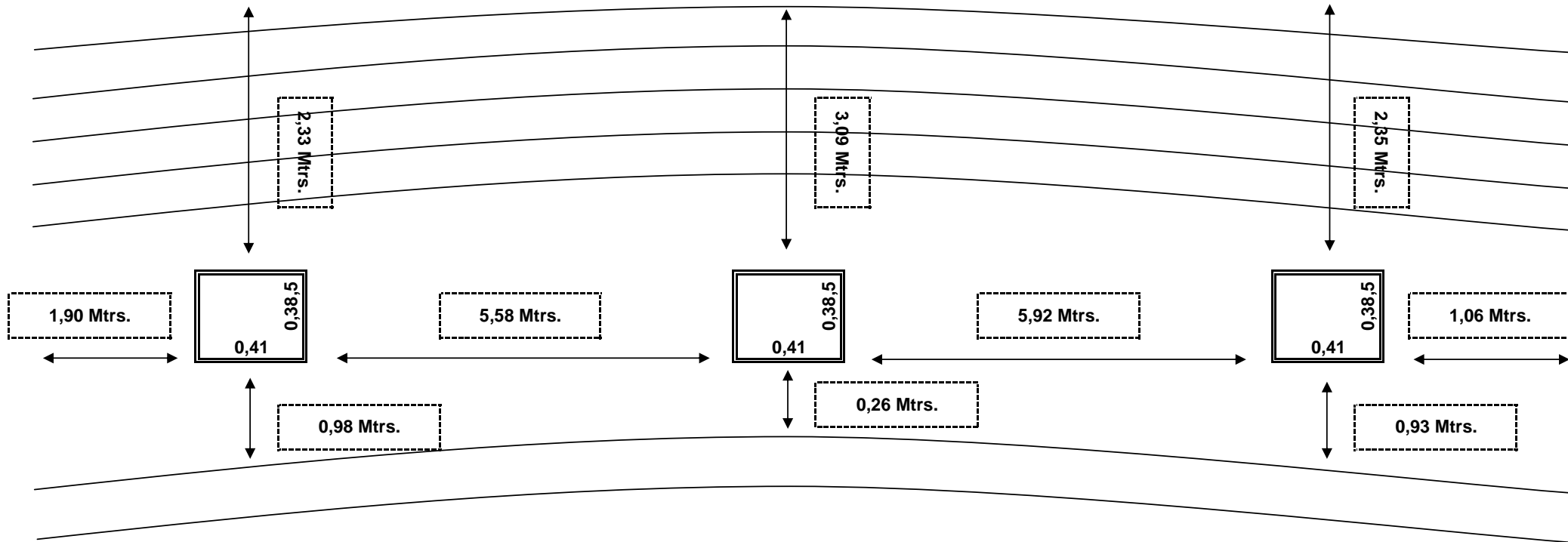

ALTURA 2,41 Mtrs.

MEDIDAS HALL DE CABALLERIZAS

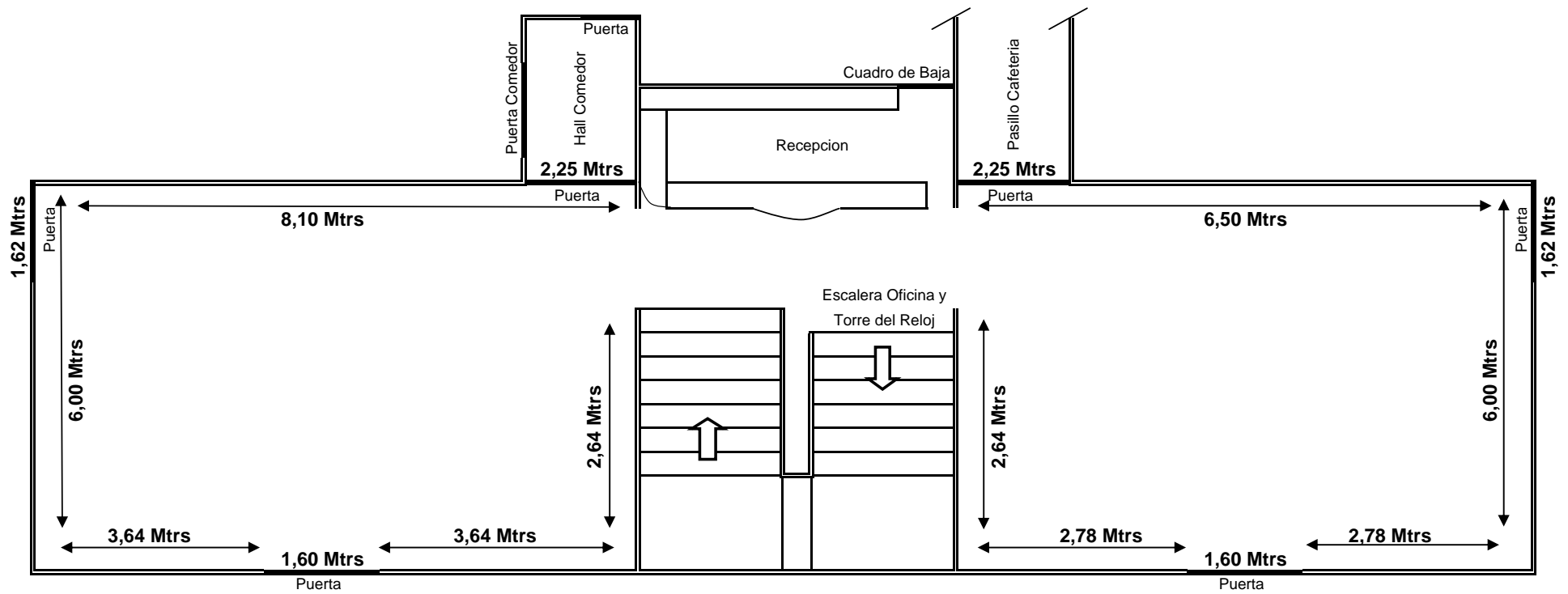

MEDIDAS PANELES DE PALACIO

PANEL EXPOSITOR

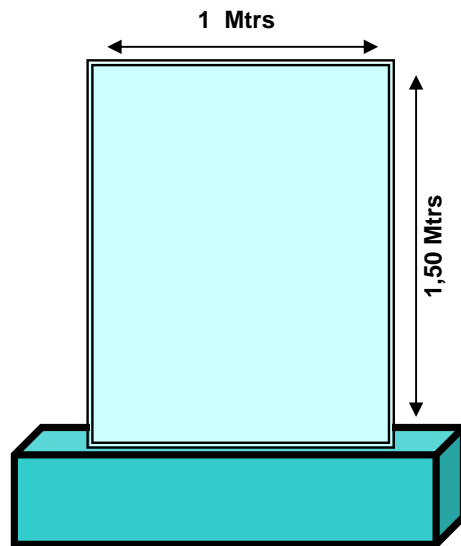

PANEL DE SEÑALIZACION

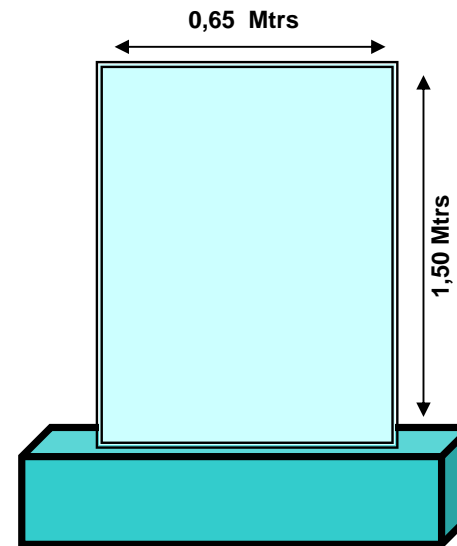

MEDIDAS MESAS COMEDOR DE PALACIO

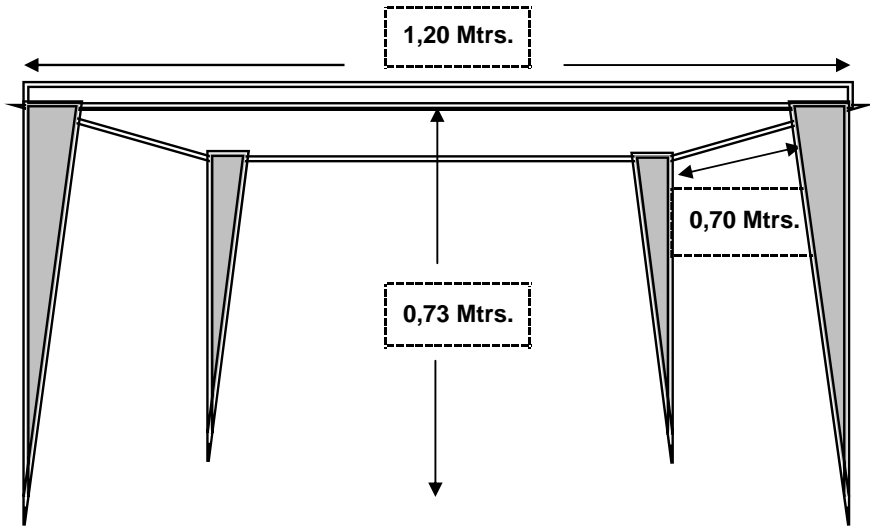

MESAS RECTANGULARES
UNIDADES : 30
4 PERSONAS POR UNIDAD

MESAS OVALADAS
UNIDADES : 2
10 PERSONAS POR UNIDAD

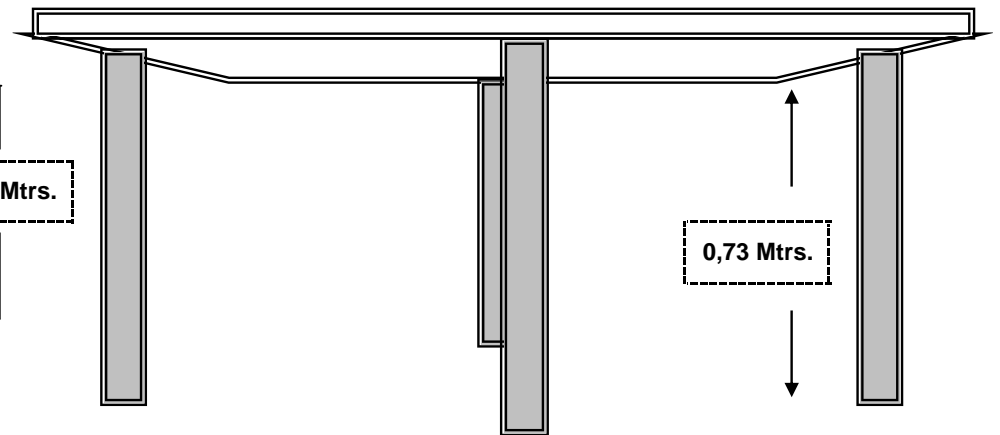
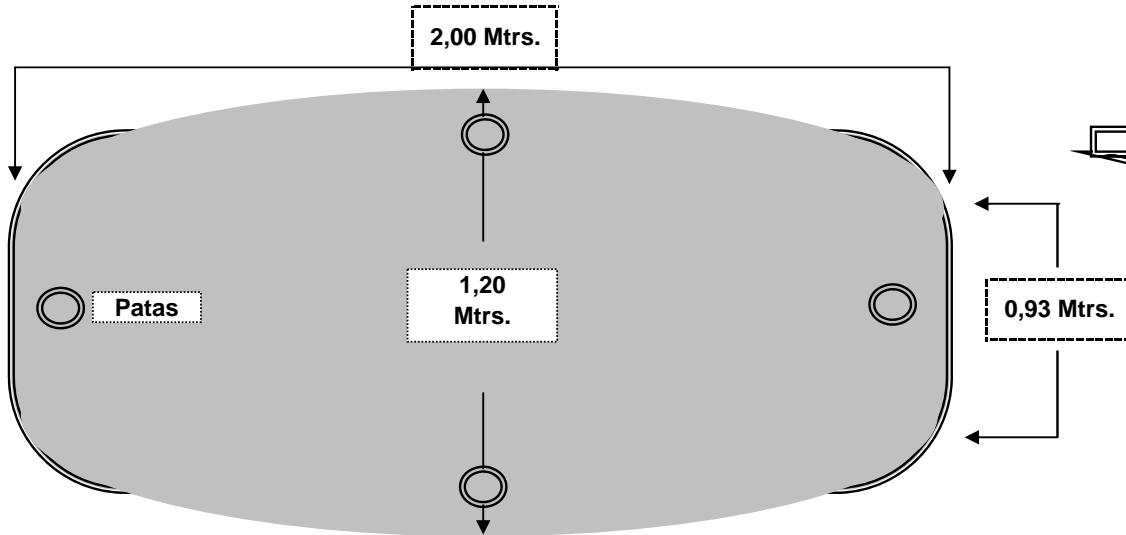

MEDIDAS MESAS COMEDOR DE CABALLERIZAS

MESAS RECTANGULARES UNIDADES : 12

4 PERSONAS POR UNIDAD

1,00 Mtrs.

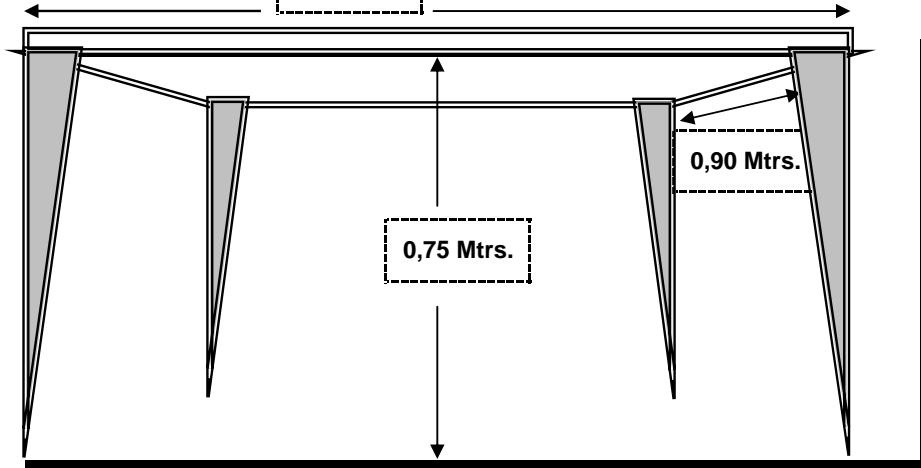

0,75 Mtrs.

0,90 Mtrs.

2,00 Mtrs.

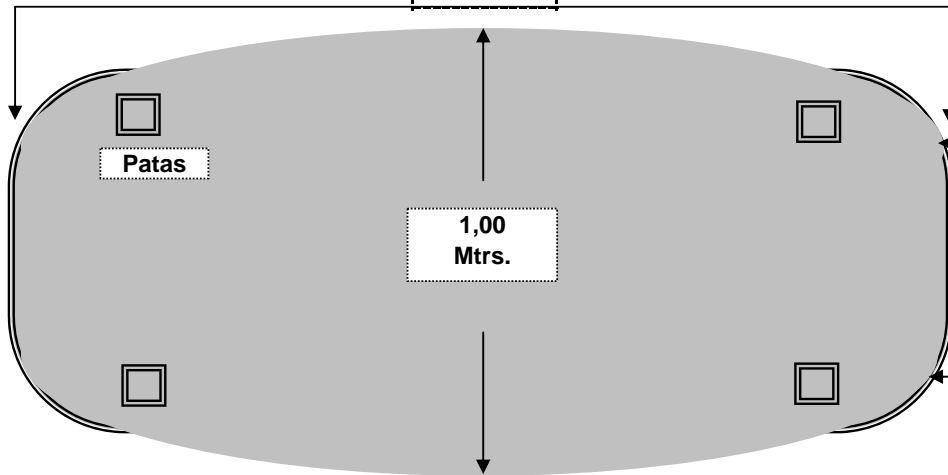

Patas

1,00 Mtrs.

0,70 Mtrs.

MESAS OVALADAS UNIDADES : 5

4 MESAS DE 8 PERSONAS POR UNIDAD

1 MESA DE 10 PERSONAS

0,80 Mtrs.

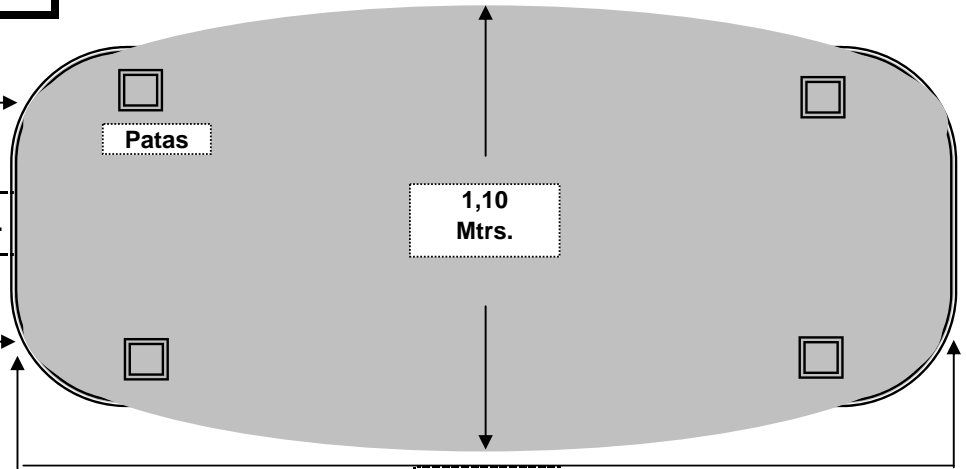

Patas

1,10 Mtrs.

2,30 Mtrs.

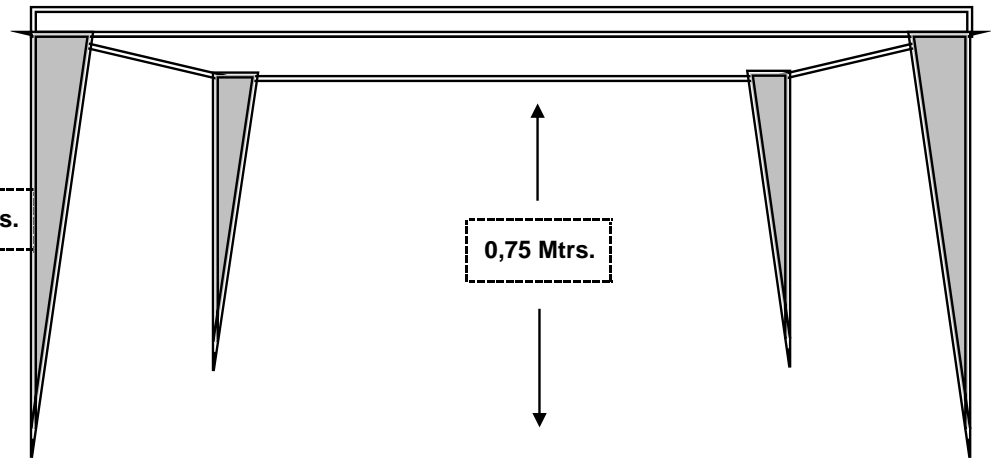

0,75 Mtrs.

MEDIDAS MESAS COMEDOR DE CABALLERIZAS

1 MESA REDONDA PARA 12 PERSONAS

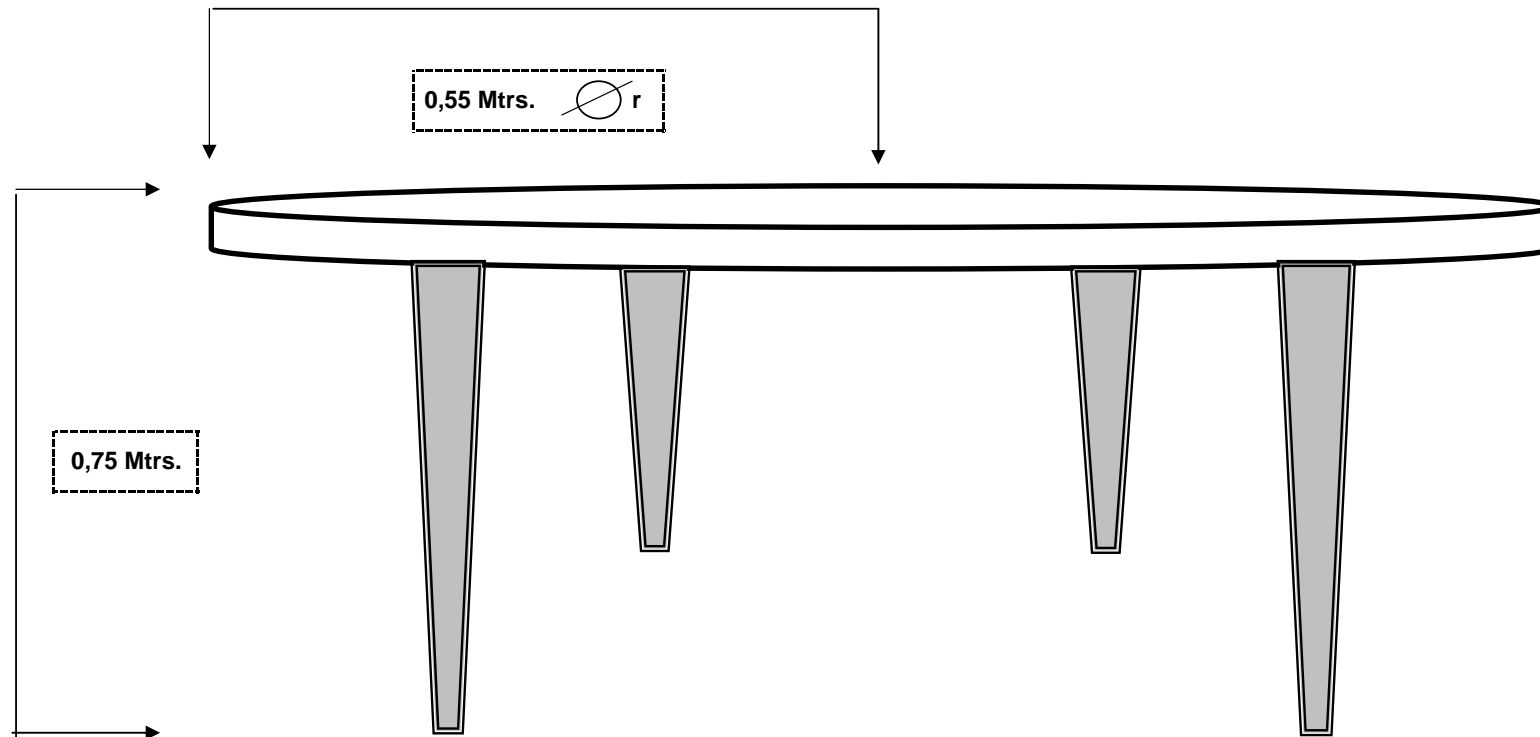

MEDIDAS ATRILES AULAS PALACIO

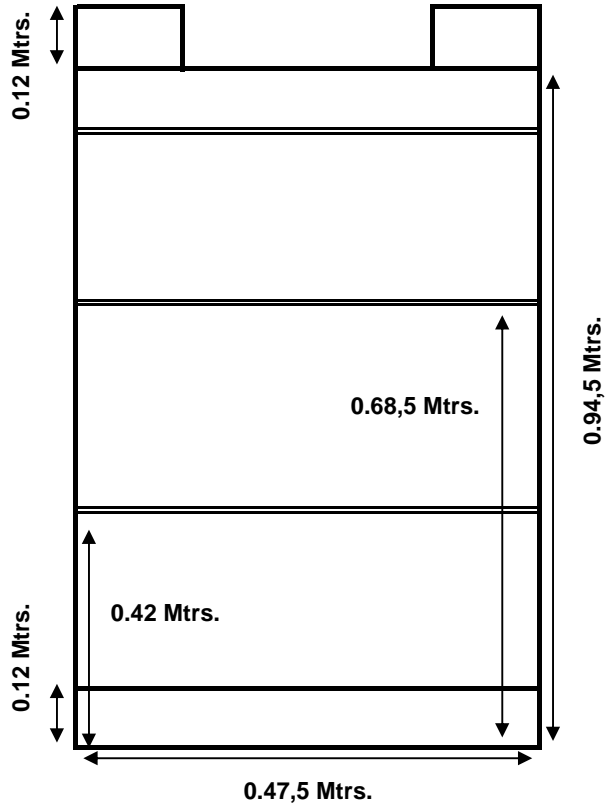
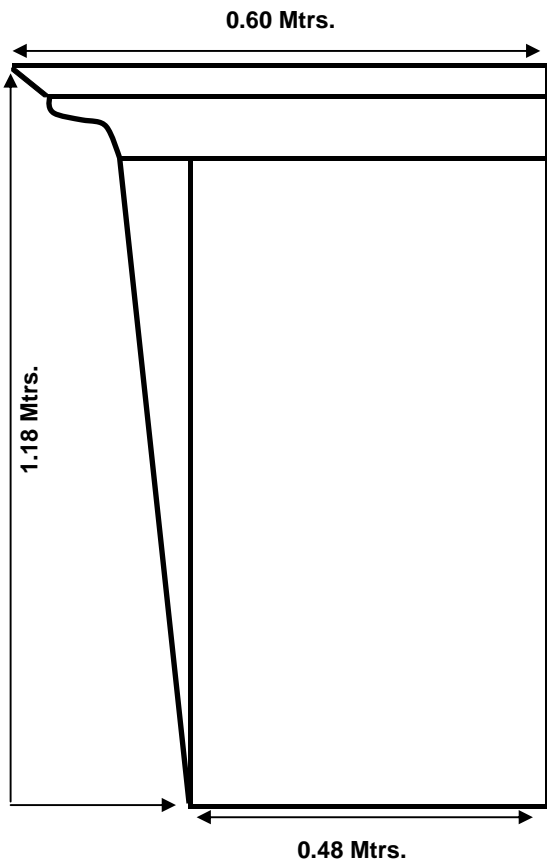

FRONTAL PARA CARTEL
1,07 X 0,51 Mtrs.

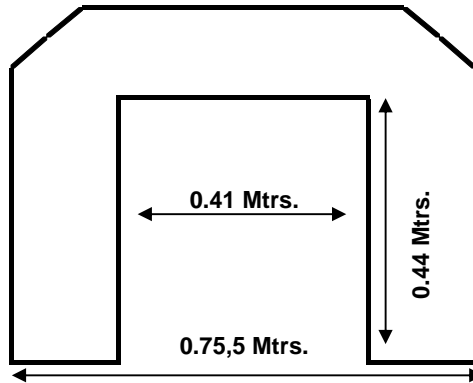

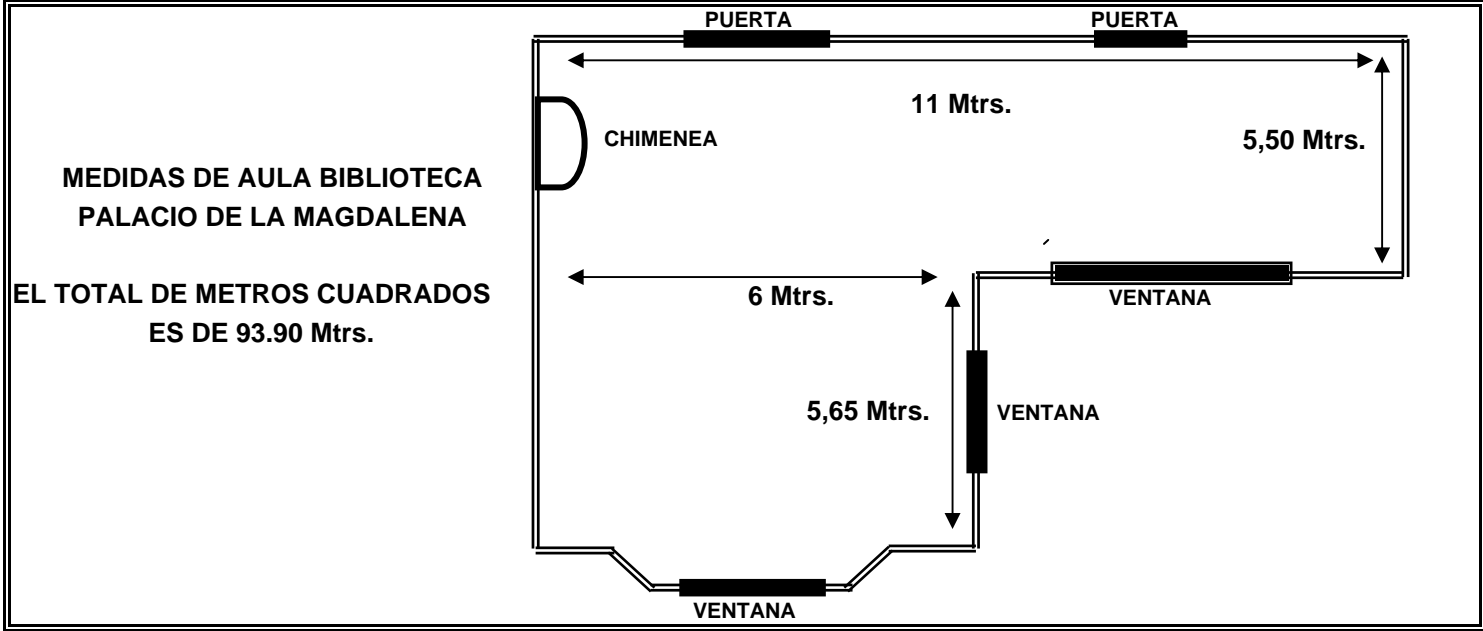

MEDIDAS CHIMENEA HALL PRINCIPAL

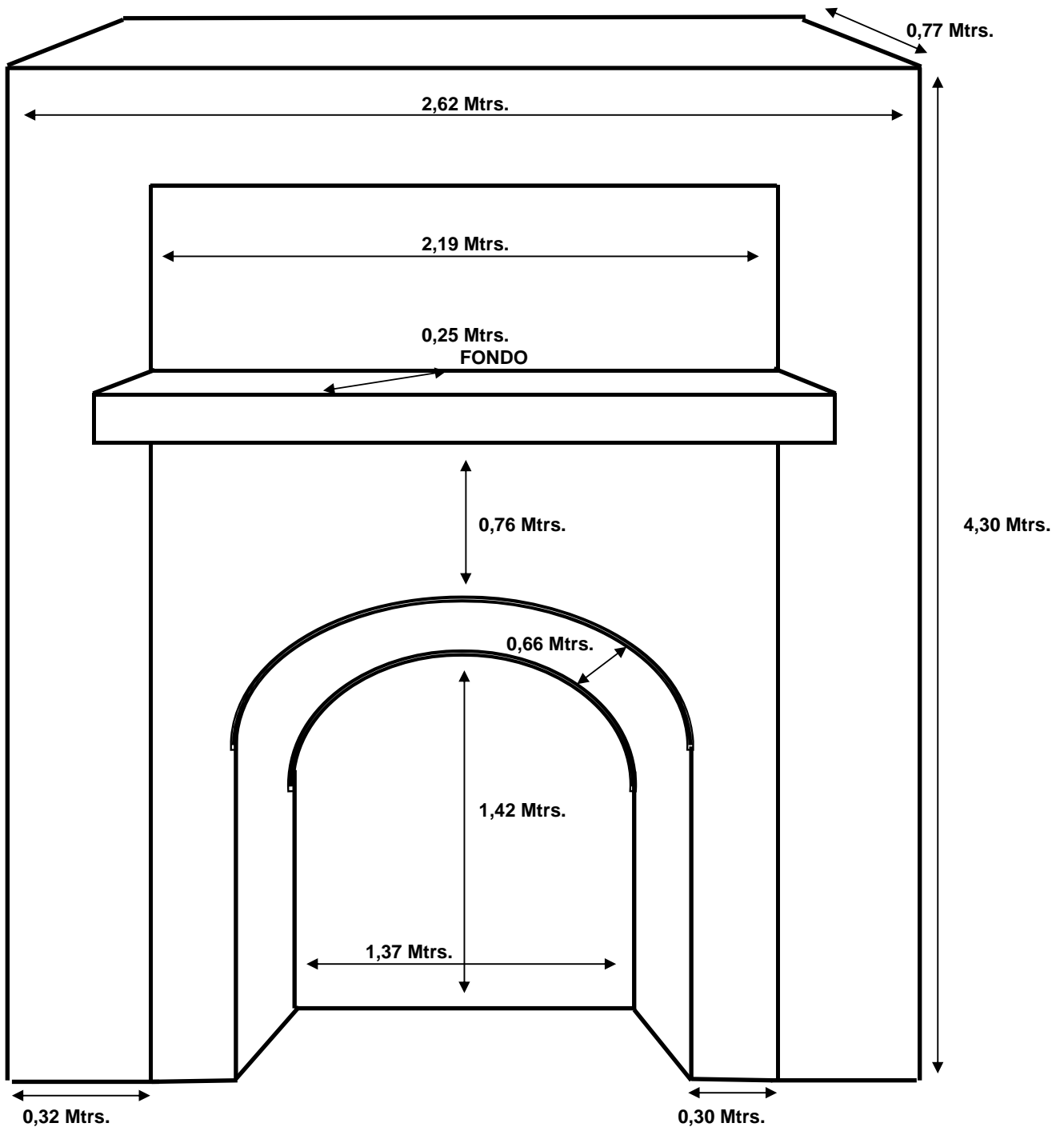

MEDIDAS AULA BRINGAS

7,6 Mtrs.

1,57Mtrs.

ESTRADO

8 Mtrs.

1,65 Mtrs.

PUERTA

5 Mtrs.

2,90 Mtrs.

VENTANA Y PUERTA

1,30 Mtrs.

ALTURA 4 Mtrs.

4 Mtrs.

VENTANAL

